

PHYSICS (SPECIFICATION A)
Unit 4 Waves, Fields and Nuclear Energy

PA04

Section A

Friday 21 June 2002 Afternoon Session

In addition to this paper you will require:

- an objective test answer sheet;
- a black or blue ball-point pen;
- a calculator;
- a question paper/answer book for Section B (enclosed).

Time allowed: The total time for Section A and Section B of this paper is 1 hour 30 minutes

Instructions

- Use a blue or black ball-point pen. Do **not** use pencil.
- Answer **all** questions in this section.
- For each question there are four responses. When you have selected the response which you think is the best answer to a question, mark this response on your answer sheet.
- Mark all responses as instructed on your answer sheet. If you wish to change your answer to a question, follow the instructions on your answer sheet.
- Do all rough work in this book, **not** on the answer sheet.

Information

- The maximum mark for this section is 30.
- Section A and Section B of this paper together carry 15% of the total marks for Physics Advanced.
- All questions in Section A carry equal marks. No deductions will be made for incorrect answers.
- A *Data Sheet* is provided on pages 3 and 4. You may wish to detach this perforated sheet at the start of the examination.
- The question paper/answer book for Section B is enclosed within this question paper.

Data Sheet

- A perforated *Data Sheet* is provided as pages 3 and 4 of this question paper.
- This sheet may be useful for answering some of the questions in the examination.
- You may wish to detach this sheet before you begin work.

SECTION A

In this section each item consists of a question or an incomplete statement followed by four suggested answers or completions. You are to select the most appropriate answer in each case.

- 1 A mass M hangs in equilibrium on a spring. M is made to oscillate about the equilibrium position by pulling it down 10 cm and releasing it. The time for M to travel back to the equilibrium position for the first time is 0.50 s. Which line, **A** to **D**, is correct for these oscillations?

	amplitude/cm	period/s
A	10	1.0
B	10	2.0
C	20	2.0
D	20	1.0

- 2 A wave motion has period T , frequency f , wavelength λ and speed v . Which one of the following equations is **incorrect**?

A $1 = Tf$

B $T = \frac{v}{\lambda}$

C $\lambda = \frac{v}{f}$

D $Tv = \lambda$

- 3 Which one of the following statements is true when an object performs simple harmonic motion about a central point O?

A The acceleration is always away from O.

B The acceleration and velocity are always in opposite directions.

C The acceleration and the displacement from O are always in the same direction.

D The graph of acceleration against displacement is a straight line.

Turn over ►

4

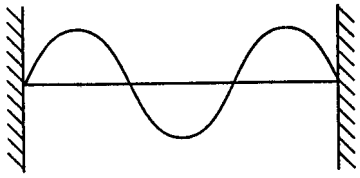

frequency of vibration = 50 Hz

The diagram above shows a stationary wave on a stretched string at a time $t = 0$. Which one of the diagrams, **A** to **D**, correctly shows the position of the string at a time $t = 0.010$ s?

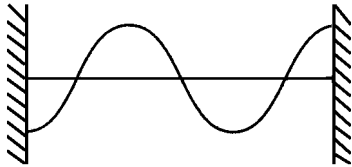
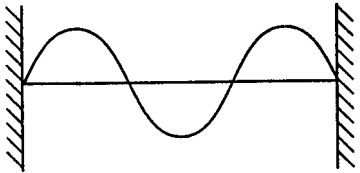
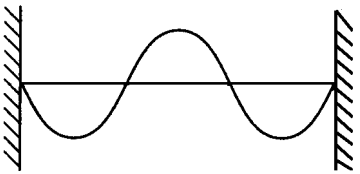
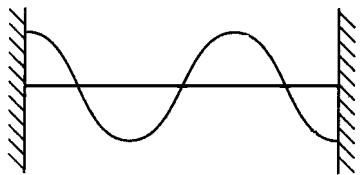
A**B****C****D**

5

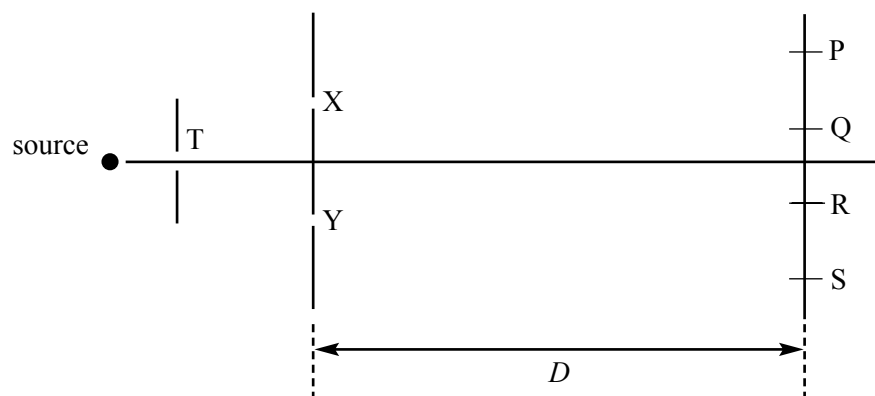

Coherent monochromatic light of wavelength λ emerges from the slits X and Y to form dark fringes at P, Q, R and S in a double slit apparatus. Which one of the following statements is true?

- A** When the distance D is increased, the separation of the fringes increases.
- B** When the distance between X and Y is increased, the separation of the fringes increases.
- C** When the width of the slit T is decreased, the separation of the fringes decreases.
- D** There is a dark fringe at P because $(YP - XP)$ is 2λ .
- 6** Monochromatic light of wavelength 590 nm is incident normally on a plane diffraction grating having 4×10^5 lines m^{-1} . An interference pattern is produced. What is the highest order visible in this interference pattern?
- A** 2
- B** 3
- C** 4
- D** 5
- 7** A capacitor of capacitance C stores an amount of energy E when the p.d. across it is V . Which line, **A** to **D**, gives the correct stored energy and p.d. when the charge is increased by 50%.

	energy	p.d.
A	$1.5E$	$1.5V$
B	$2.25E$	$1.5V$
C	$1.5E$	$2.25V$
D	$2.25E$	$2.25V$

Turn over ►

8 A girl of mass 40 kg stands on a roundabout 2.0 m from the vertical axis as the roundabout rotates uniformly with a period of 3.0 s. The horizontal force acting on the girl is approximately

- A zero.
- B 3.5×10^2 N.
- C 7.2×10^2 N.
- D 2.8×10^4 N.

9 Which one of the following graphs correctly shows the relationship between the gravitational force, F , between two masses and the distance, r , between them?

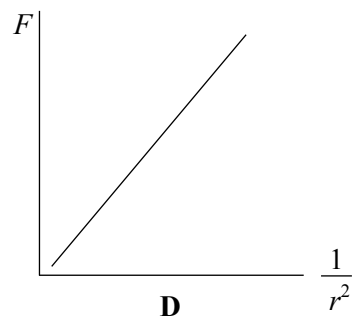
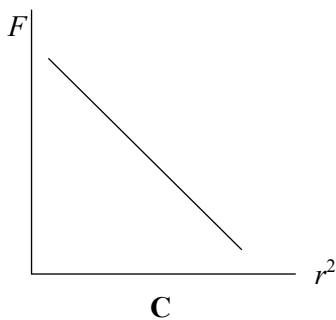
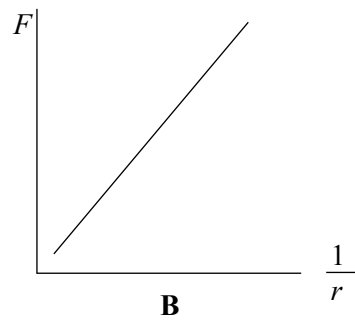
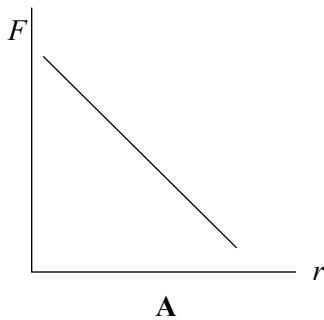

10 For a particle moving in a circle with uniform speed, which one of the following statements is **incorrect**?

- A The velocity of the particle is constant.
- B The force on the particle is always perpendicular to the velocity of the particle.
- C There is no displacement of the particle in the direction of the force.
- D The kinetic energy of the particle is constant.

11 A satellite is in orbit at a height h above the surface of a planet of mass M and radius R . What is the velocity of the satellite?

A $\sqrt{\frac{GM(R+h)}{R}}$

B $\sqrt{\frac{GM(R+h)}{R}}$

C $\sqrt{\frac{GM}{(R+h)}}$

D $\frac{\sqrt{GM}}{(R+h)}$

12

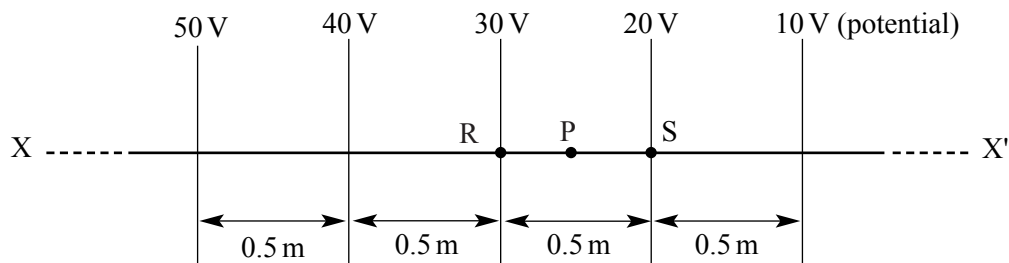

The diagram shows how the electric potential varies along a line XX' in an electric field. What will be the electric field strength at a point P on XX' which is mid-way between R and S?

A 5.0 V m^{-1}

B 10 V m^{-1}

C 20 V m^{-1}

D 30 V m^{-1}

Turn over ►

13

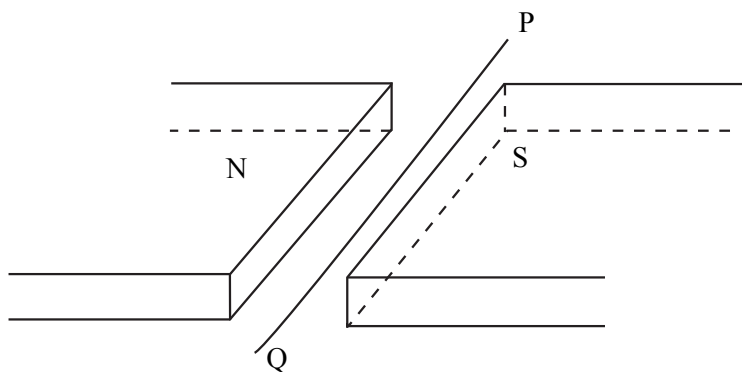

A wire lies perpendicularly across a horizontal uniform magnetic field of flux density $20 \times 10^{-3} \text{ T}$ so that 0.30 m of the wire is effectively subjected to the field. If the force exerted on this length of wire due to a current in it is $30 \times 10^{-3} \text{ N}$ downward, what is the current in the wire?

- A** 0.45 A from P to Q
- B** 0.45 A from Q to P
- C** 5.0 A from P to Q
- D** 5.0 A from Q to P
- 14** An electron moves due North in a horizontal plane with uniform speed. It enters a uniform magnetic field directed due South in the same plane. Which one of the following statements concerning the motion of the electron in the magnetic field is correct?
- A** It continues to move North with its original speed.
- B** It slows down to zero speed and then accelerates due South.
- C** It is accelerated due West.
- D** It is accelerated due North.
- 15** The nuclear fuel, which provides the power output in a nuclear reactor, decreases in mass at a rate of $6.0 \times 10^{-6} \text{ kg}$ per hour. What is the maximum possible power output of the reactor?
- A** 42 kW
- B** 75 MW
- C** 150 MW
- D** 300 MW

END OF SECTION A

THERE ARE NO ITEMS PRINTED ON THIS PAGE

THERE ARE NO ITEMS PRINTED ON THIS PAGE

Surname		Other Names	
Centre Number		Candidate Number	
Candidate Signature			

Leave blank

General Certificate of Education
June 2002
Advanced Level Examination



Physics (SPECIFICATION A)
Unit 4 Waves, Fields and Nuclear Energy

PA04

Section B

Friday 21 June 2002 Afternoon Session

<p>In addition to this paper you will require:</p> <ul style="list-style-type: none"> • a calculator; • a pencil and a ruler.
--

Time allowed: The total time for Section A and Section B of this paper is 1 hour 30 minutes

Instructions

- Use a blue or black ball-point pen.
- Fill in the boxes at the top of this page.
- Answer **all** questions in the spaces provided. All working must be shown.
- Do all rough work in this book. Cross through any work you do not want marked.

Information

- The maximum mark for this Section is 30.
- Mark allocations are shown in brackets.
- Section A and Section B of this paper together carry 15% of the total marks for Physics Advanced.
- A *Data sheet* is provided on pages 3 and 4 of Section A. You may wish to detach this perforated sheet at the start of the examination.
- You are expected to use a calculator where appropriate.
- In questions requiring description and explanation you will be assessed on your ability to use an appropriate form and style of writing, to organise relevant information clearly and coherently, and to use specialist vocabulary where appropriate. The degree of legibility of your handwriting and the level of accuracy of your spelling, punctuation and grammar will also be taken into account.

For Examiner's Use			
Number	Mark	Number	Mark
1			
2			
3			
4			
Total (Column 1)	→		
Total (Column 2)	→		
TOTAL			
Examiner's Initials			

1 To celebrate the Millennium in the year 2000, a footbridge was constructed across the River Thames in London. After the bridge was opened to the public it was discovered that the structure could easily be set into oscillation when large numbers of pedestrians were walking across it.

(a) What name is given to this kind of physical phenomenon, when caused by a periodic driving force?

.....
(1 mark)

(b) Under what condition would this phenomenon become particularly hazardous? Explain your answer.

.....
.....
.....
.....
.....
.....
(4 marks)

(c) Suggest **two** measures which engineers might adopt in order to reduce the size of the oscillations of a bridge.

measure 1

.....

measure 2

.....
(2 marks)

7

- 2 A student used a voltage sensor connected to a datalogger to plot the discharge curve for a $4.7\ \mu\text{F}$ capacitor. She obtained the following graph.

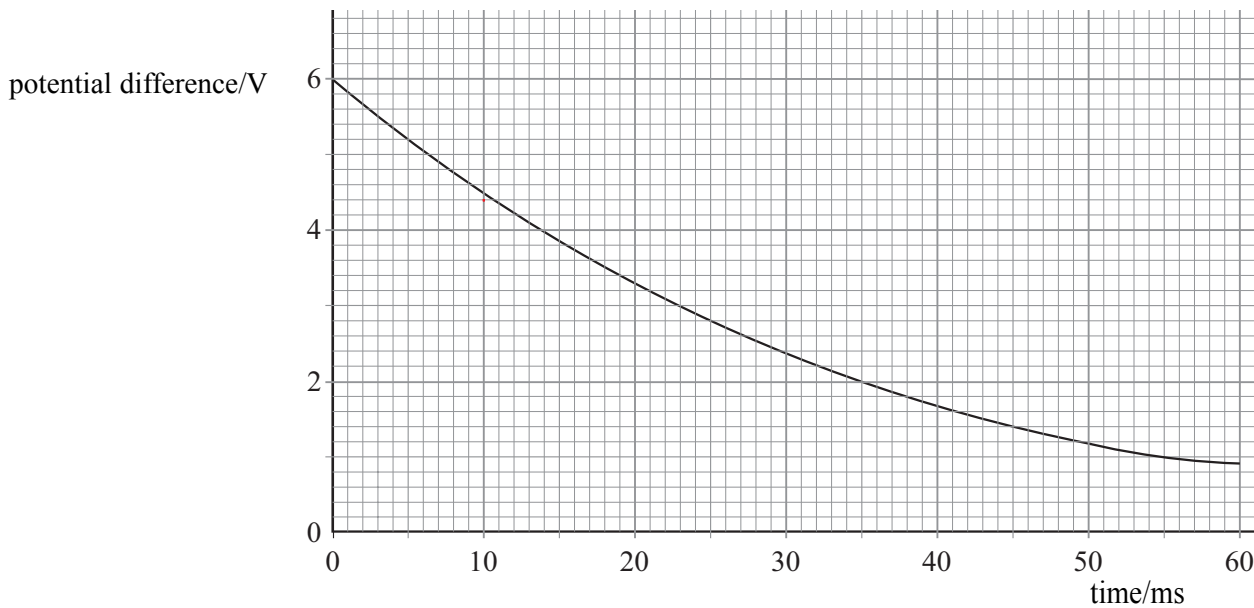

Use data from the graph to calculate

- (a) the initial charge stored,

..... (2 marks)

- (b) the energy stored when the capacitor had been discharging for 35 ms,

.....
..... (3 marks)

- (c) the time constant for the circuit,

.....
.....
..... (3 marks)

- (d) the resistance of the circuit through which the capacitor was discharging.

.....
..... (2 marks)

- 3 A rectangular coil measuring 20 mm by 35 mm and having 650 turns is rotating about a horizontal axis which is at right angles to a uniform magnetic field of flux density 2.5×10^{-3} T. The plane of the coil makes an angle θ with the vertical, as shown in the diagrams.

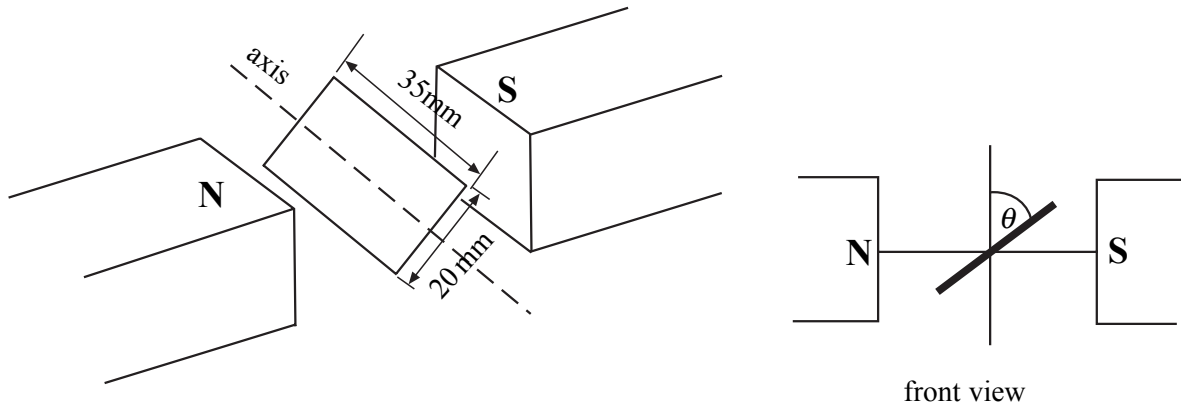

- (a) State the value of θ when the magnetic flux through the coil is a minimum.

.....
(1 mark)

- (b) Calculate the magnetic flux passing through the coil when θ is 30° .

.....
.....
(2 marks)

- (c) What is the maximum *flux linkage* through the coil as it rotates?

.....
.....
.....
(2 marks)

- 4 (a) In the reactor at a nuclear power station, uranium nuclei undergo *induced fission* with *thermal neutrons*. Explain what is meant by each of the terms in italics.

.....

.....

.....

.....

.....

(3 marks)

- (b) A typical fission reaction in the reactor is represented by

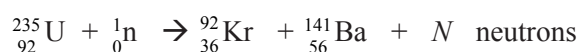

- (i) Calculate N .

.....

- (ii) How do the neutrons produced by this reaction differ from the initial neutron that goes into the reaction?

.....

.....

- (iii) Calculate the energy released in MeV when one uranium nucleus undergoes fission in this reaction. Use the following data.

mass of neutron = 1.00867 u

mass of ${}^{235}\text{U}$ nucleus = 234.99333 u

mass of ${}^{92}\text{Kr}$ nucleus = 91.90645 u

mass of ${}^{141}\text{Ba}$ nucleus = 140.88354 u

1 u is equivalent to 931 MeV

.....

.....

.....

.....

.....

(5 marks)

8

END OF QUESTIONS

THERE ARE NO QUESTIONS PRINTED ON THIS PAGE

THERE ARE NO QUESTIONS PRINTED ON THIS PAGE

THERE ARE NO QUESTIONS PRINTED ON THIS PAGE